



Materials for the Electrification of the Powertrain

/ 1. THE CHALLENGE IN DEVELOPING ELECTRIFIED POWERTRAINS

The challenge for those looking to electrify powertrains in automotive and aerospace applications is essential to solve at both strategic and technical levels. Engineers are on the front line of an electrification revolution that must take place, and materials are evolving quickly to enable this revolution. Finding materials with the right thermal, structural, and electromagnetic properties for the components of future electric powertrains is an important part of this puzzle. In the case of battery electric vehicles (BEVs), mass market adoption requires cell price reductions from \$100/kWh today to \$76/kWh. Considering that 75% of the battery cell price is determined by the material, tools for finding, selecting, and managing the right material data are increasingly important. Many Original Equipment Manufacturers (OEMs) and suppliers have developed proprietary material data, making material information management systems, like **Ansys Granta MI™**, business critical.

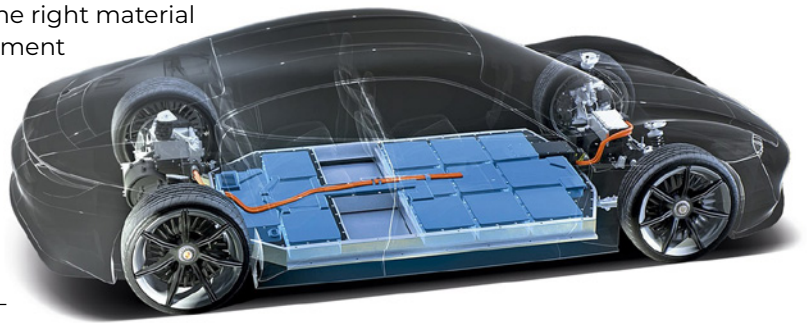

Figure 1. 75% of the battery cell price is determined by the materials used (credit: Porsche)

If we look at the BEV powertrain cost breakdown, the battery system — including cells, wiring, and housing — contributes 80% of the production cost, with the remaining 20% from the e-Axle and high voltage systems and auxiliaries. By selecting, comparing, and managing the materials associated with each of these components, OEMs and suppliers can tackle thermal, structural, electromagnetic, and weight challenges to differentiate their BEV offering.

It is not just the automotive sector that is seeing this shift toward electrification; commercial and military applications in the aerospace sector are also making the transition. Engineers are again challenged with the trade-off between prospective energy sources with appropriate energy densities and their weight, cost, and durability, all while trying to maximize the design's sustainability.

Projects to build new power systems knowledge for aircraft continue to appear: The Accel project, involving Rolls-Royce and Electroflight, among others, successfully broke the electric airspeed record in 2021 (Figure 3). **Selecting the right material** was a major step in that journey.

TYPICAL COST BREAKDOWN BEV POWERTRAIN

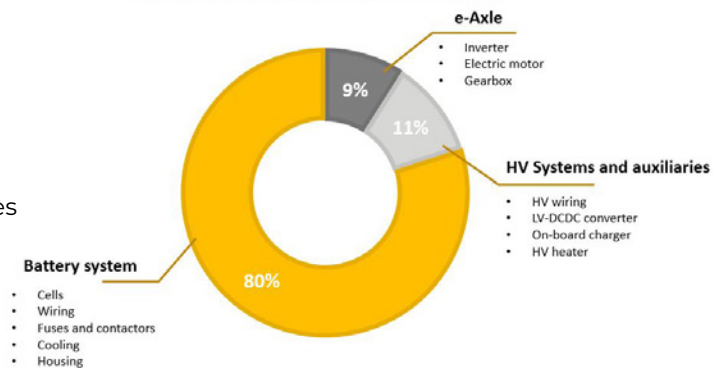
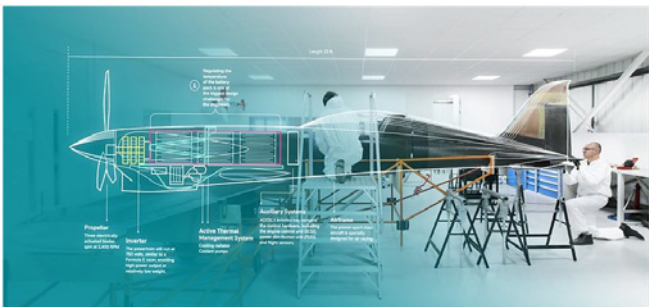

Figure 2 BEV powertrain cost breakdown (source: PWC powertrain study 2020)



What's clear is that the challenges are complex and increasingly require a multiphysics approach to tackle the interrelated trade-offs that need to be made. This white paper outlines where materials fit into this challenge, the solutions Ansys offers, and how they can be factored into a wider multiphysics approach to produce the next generation of electrified powertrains.

Figure 3 Electrification of the powertrain in the aerospace industry (source: Electroflight)

/ 2. MAKE SMARTER MATERIAL CHOICES FOR YOUR ELECTRIFIED POWERTRAIN

To exemplify the impact materials can have on an electrified powertrain, this section breaks out core elements of the BEV powertrain (Figure 4). Various Ansys Granta tools and solutions can be applied to help engineers address the challenge outlined above. These solutions are then applied at a multiphysics level with the most relevant Ansys solvers to provide a holistic overview. (For more information, refer to section 3.)

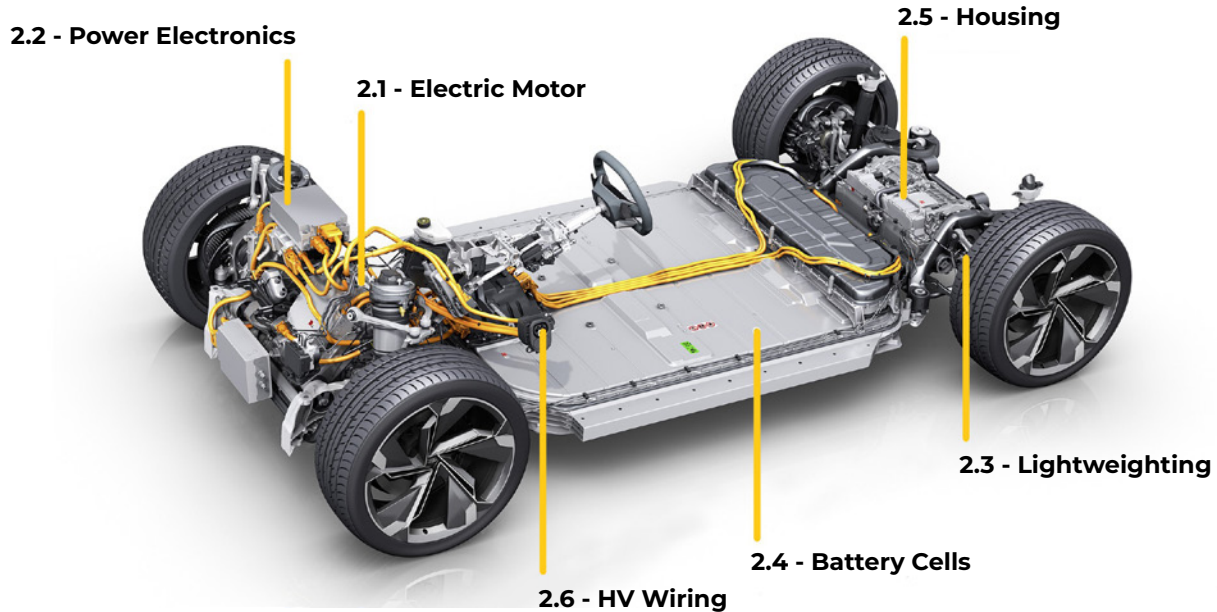

Figure 4 Components within a typical BEV powertrain (credit: Audi)

/ 2.1. ELECTRIC MOTORS

The Right Material Properties. For the Right Electric Motor.

Despite being a relatively small part of the overall BEV powertrain cost, getting the electric motor right is critical to performance and efficiency — both differentiators in the market. Materials data for various components of the motor (Figure 5), from stator windings, thermal insulation, and rotor shafts, can be found in our core **Ansys MaterialUniverse™** and **JAHM** temperature-dependent materials dataset (included with **Ansys Granta Selector** and **Ansys Granta MI™**) and across **Ansys Granta Advanced Materials — Polymer, Metals and Composites** data sets.

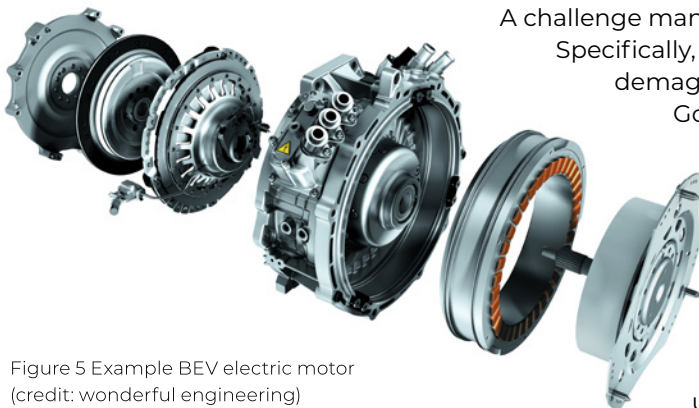

Figure 5 Example BEV electric motor (credit: wonderful engineering)

A challenge many engineers are faced with when designing motors is heat. Specifically, higher temperatures can reduce the “knee point” in the demagnetization curves (or hysteresis curve) of permanent magnets. Going beyond this point causes irreversible damage to the magnet, leading to a reduction in motor performance. Data on these curves at different temperatures is available in **Ansys Granta Advanced Materials — Electromagnetic** (Figure 6), which you can use with electronics simulation solvers like **Ansys Maxwell**.

Axial flux motor design in particular presents engineers with mechanical and thermal challenges, where a holistic understanding of electromagnetic (EM) forces and material’s properties become very important. The strong magnetic forces operating between the rotor and stator make keeping high-tolerance, uniform air gaps between these two components critical, while the positioning of the windings deep within the stator and between the two rotor discs poses a bigger cooling problem. Understanding the temperature-dependent material properties for these components within this type of motor assembly becomes an important input into any accurate simulation.

Part of the Granta core offering is JAHM temperature-dependant data, with 18,000+ records for more than 8,500 different materials (polymers, metals, ceramics, composites, etc.). Thirty-two different key properties (many of them temperature dependent) are available, including stress-strain, thermal expansion/conductivity, specific heat capacity, S-N fatigue curves, and electrical and magnetic properties.

Magnetic Materials from Ansys. Specifically for Electric Motor Simulation.

Key components are the magnets on the rotor. Information on these magnets can be found in the **Granta Advanced Materials — Electromagnetic** data set (new in the Ansys 2022 R1 release):

- 650+ records of soft magnetic alloys
- 1,300+ records of permanent magnets

Within Granta MI™ and Granta Selector tools, there is information on specific grades of magnets, with the capability of selecting and comparing a variety of material properties:

- Magnetic — coercivity, remanence, B-H curve (Figure 6) and core loss
- Mechanical — Young’s modulus, yield strength, tensile strength, elongation, and Poisson’s ratio
- Density
- Thermal — conductivity, specific heat capacity, coefficient of thermal expansion and maximum service temperature
- Electrical — conductivity and resistivity

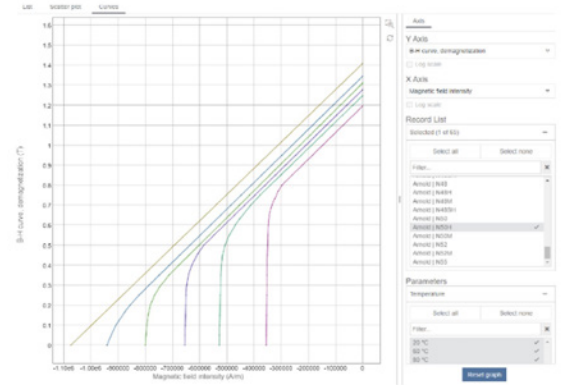

Figure 6 B-H curve data in Granta MI

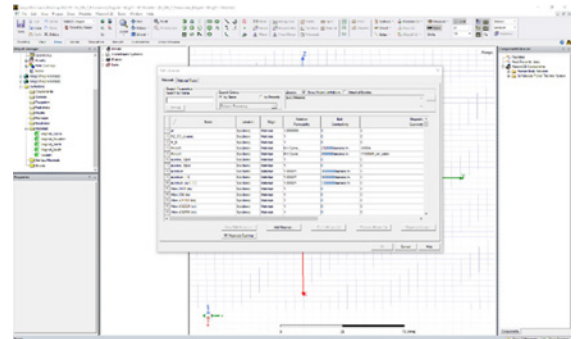

Figure 7 Easily access data in Ansys Electronics Desktop with MI Materials Gateway

The Ansys Multiphysics Solution.

Native access to Granta MI™ and its data within Maxwell (Figure 7), along with access to **Ansys Mechanical** via **Ansys Workbench’s** engineering data module, quickly gives you accurate materials property data for a variety of magnetic, metallic, or polymer materials used in the design, analysis, and verification of an electric motor. This connection ensures full traceability of the data back to the material record and statistical and test data sources. The material card is imported to the local project and can then be used and assigned accordingly. This information can be also easily exported from Granta Selector.

Using **Ansys Multiphysics** to optimize a BEV motor is not new. The team at Lucid Motors, a luxury electronic vehicle OEM, used Maxwell for the design and analysis of electric motors, actuators, sensors, transformers, and other electromagnetic and electromechanical devices. [Watch this video](#) for more about Ansys solutions for electric machines and drives.

Maxwell was used to determine the electromagnetic losses in the motor. Workbench integrated these losses with an **Ansys Fluent** simulation to determine temperatures throughout the motor (Figure 8).

Using simulation, the engineers at Lucid Motors increased the power density and energy efficiency of the motor by 12% using a combination of Maxwell, Mechanical and Fluent. [Read the article](#) about how they achieved this.

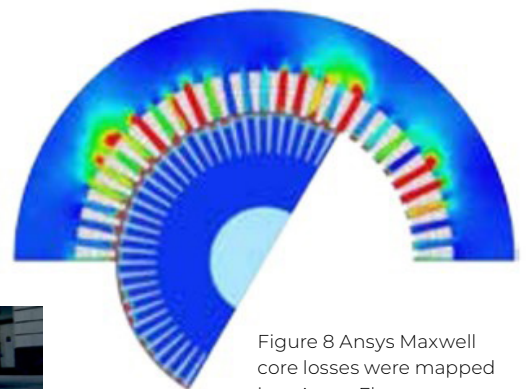

Figure 8 Ansys Maxwell core losses were mapped into Ansys Fluent to improve motor design



“Simulation enabled Lucid engineers to increase the power density and energy efficiency of the motor by 12 percent.”

/ 2.2. POWER ELECTRONICS

Material Options for High Power Electronics.

Typically, the power electronics of a modern electric vehicle (Figure 9) will comprise (1) a rectifier, (2) a DC-DC converter, (3) an input filter, and (4) an inverter. Within the power electronics control module, the AC-DC, DC-DC conversion, and the DC to 3-phase current for the electric machine require a variety of printed circuit boards (PCBs). Power electronics can run hot depending on the amount of power they are converting, and this heat must be managed. For supplies with high power, alternate board materials such as ceramics or some PTFE laminates may be needed.

Thus, identifying, comparing, and selecting PCB material grades for this application based on resin type, thermal performance, frequency-dependent performance, and durability become critical. Data for PCB materials, including laminates, with the manufacturer and grade (Figure 10) is available in **Ansys Granta Advanced Materials — Electromagnetics**, including 5,200+ records for PCB materials — laminate, prepreg, and core.

Within Granta MI™ and Granta Selector, tools can be used to select and compare these electromagnetic materials, with the following material properties:

- Resin type, IPC slash sheet, thickness
- Mechanical properties
- Thermal properties — maximum service temperature, glass transition temperature, thermal expansion coefficient
- Frequency-dependent properties — dielectric loss tangent with frequency, Df, and relative permittivity with frequency, Dk (Figure 11)
- Durability — time to decomposition at 260°C and 288°C, water absorption and conductive anodic filament resistance

Managing Material Test Data with Granta MI™

A key feature of a corporate-level material information management system such as Granta MI™ is that it can also be used to manage in-house test data. Safely storing this intellectual property and then re-distributing it to the right teams is important for fast-moving engineering projects.

For example, new data becomes available on the back of in-house testing for the dielectric loss tangent with frequency. This can be easily imported via the Import function in Granta MI™ Viewer (Figure 12):

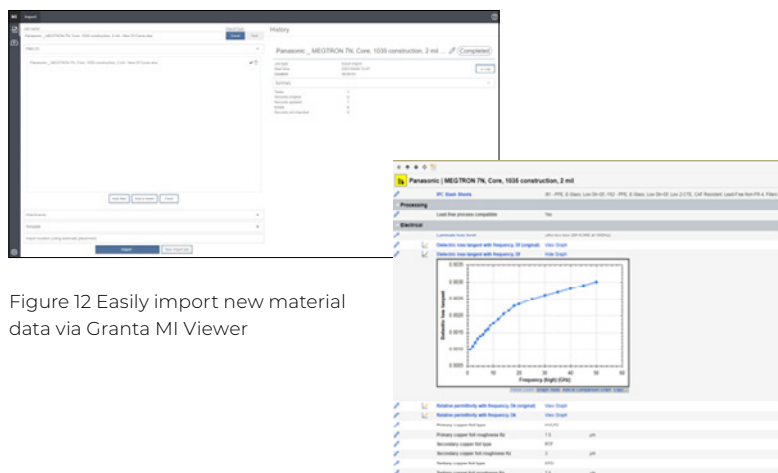

Figure 12 Easily import new material data via Granta MI Viewer

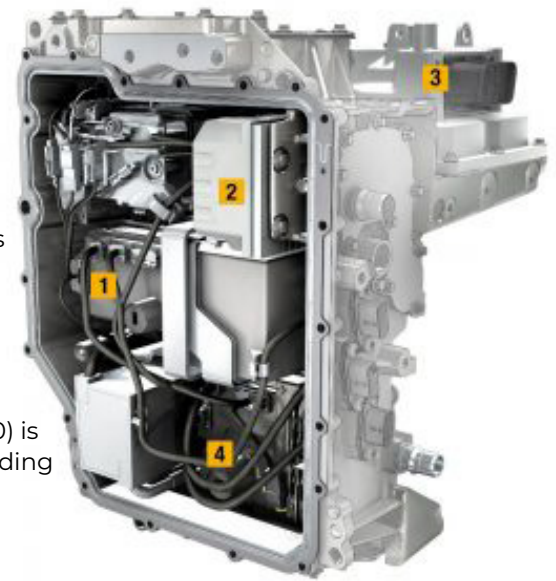

Figure 9 Power electronics from a Renault Zoe (credit; Renault)

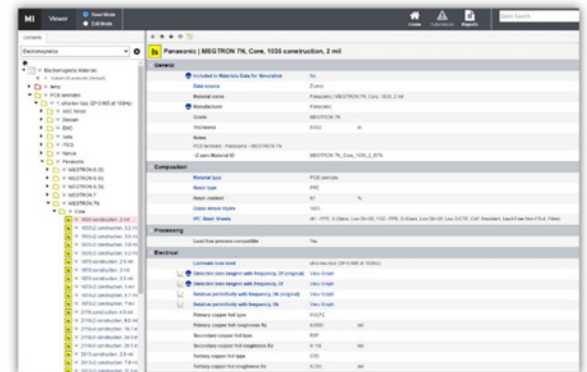

Figure 10 Example material data sheet

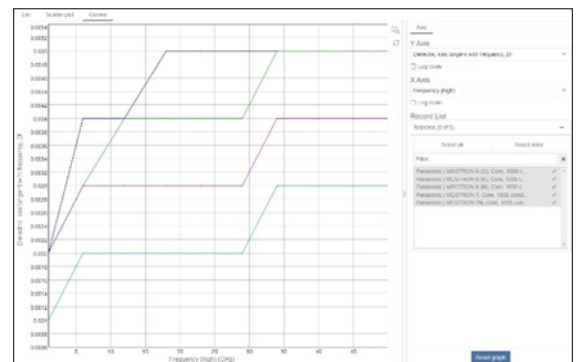

Figure 11 Comparing dielectric loss curves in Granta MI™

This updated information then becomes available as part of the material card available to your engineering teams (Figure 13). Similar data can also be exported from Granta Selector.

Figure 13 Updated material card in Granta MI Explore

The Ansys Multiphysics Solution.

Access this accurate electromagnetic, thermal, and mechanical material property data from Granta MI™ within native Ansys Electronics Desktop tools such as Maxwell, **Ansys Icepak**, and **Ansys Siwave** to improve the fidelity of your power electronics simulation. This is easily done through the MI Materials Gateway or can be exported via Granta Selector.

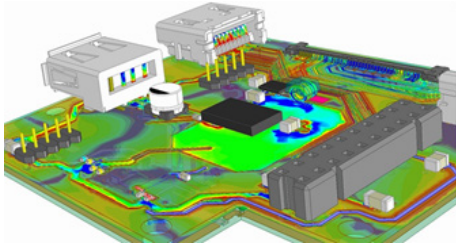

Material thermal properties can help you perform heat transfer and fluid flow simulations to arrive at thermal management solutions for electronics. You can also simulate quasi-static electromagnetic fields with frequency-dependent material properties for even more accurate models to perform signal integrity analysis.

Learn more about how Ansys applications are used in the design and optimization of power electronics [here](#).

/ 2.3. LIGHTWEIGHTING

Go Lighter. At Lower Cost. With Better Performance.

Reducing the overall weight of a vehicle is critical to BEVs because lighter weight increases energy efficiency. Lightweighting can be applied to all components in the powertrain, such as housings, drive shafts, or electric. Searching for alternative materials is an obvious tactic in achieving lighter weight.

Granta Selector offers a rapid way to compare a range of material families against a set of engineering requirements:

- Access hundreds of thousands of supplier-specific data sheets
- Eliminate unqualified material early in design
- Easily generate material cards for both Ansys and third-party simulation and CAD tools

Example: Swap-out Aluminium for Polymer for a 45% weight saving

A typical lightweighting example for the automotive industry in alternative material choices shows that a 45% reduction in weight while maintaining cost, thermal and stiffness criteria can be achieved using this application.

Initially, the current material (Al 357-T6) is compared with alternatives but while maintaining cost and stiffness criteria (Figure 14).

Figure 14 Using Granta Selector to compare alternatives

Once an alternative (PA66 with 60% glass fiber) has been identified and key material properties compared, technical, environmental, and supplier-specific grades can be found to confirm adequate stiffness and temperature resistance (Figure 15).

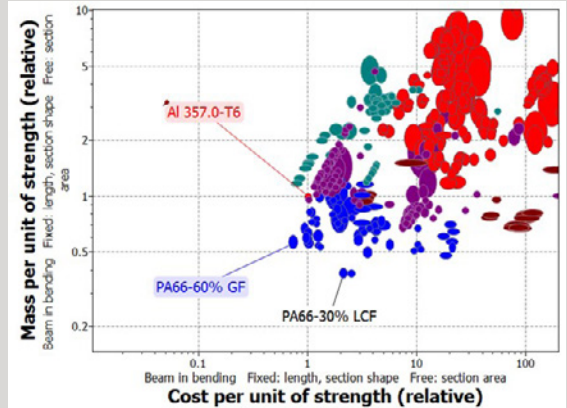

Figure 14 Using Granta Selector to compare alternatives

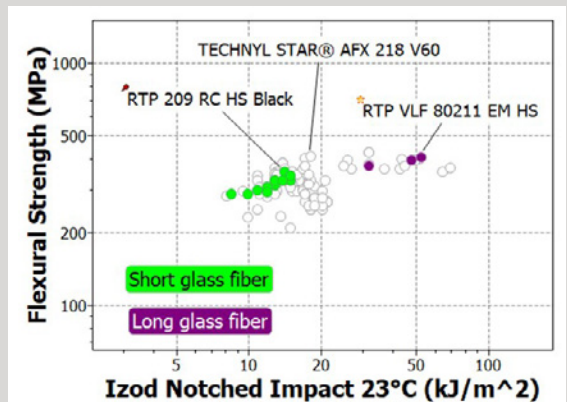

Figure 15 Example supplier specific grades of PA66 (with glass fibre) to check stiffness and thermal resistance

/ 2.4. BATTERY CELLS

Early-Stage Battery Design Configuration and Performance

Battery technology is continually developing. Granta Selector has developed a specific **Battery Designer Tool** to support engineers with early-stage design and performance comparison for multicell battery modules and packs (Figure 16). This will help you to:

1. Decide which cell(s) to choose.
2. Determine which configuration is optimal.
3. Compare the performance of the resultant battery module.

The selection tool has battery cell data with ~120 generic battery cell types and access to over 105,000 polymers in MaterialUniverse™ and **Ansys Granta Advanced Materials — Polymers** to trade-off thermal and mechanical properties for casing and insulation materials. The Battery Designer Tool also allows you to rapidly explore different high-level multicell battery module designs and carry out equivalent comparisons of their electrical and thermal performance.

The Ashby plot tools within Granta Selector enable various battery chemistry options to be evaluated for power density, specific power, specific energy, and energy density, among others (Figure 17).

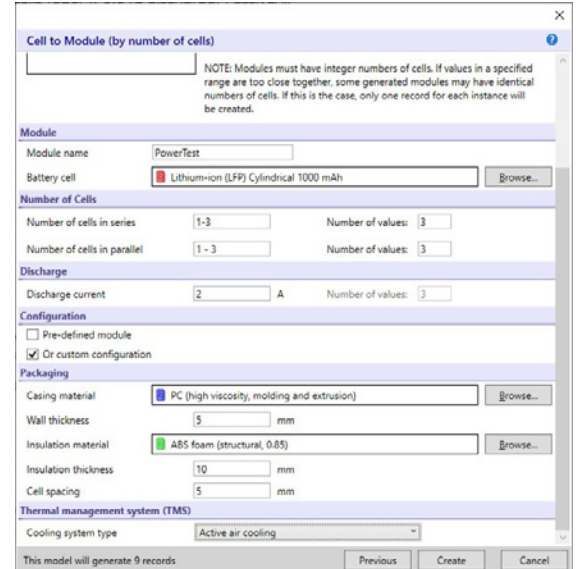
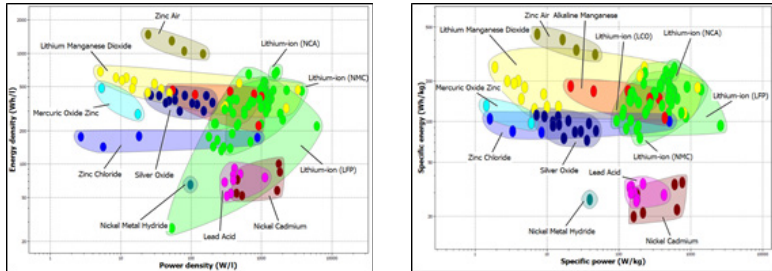
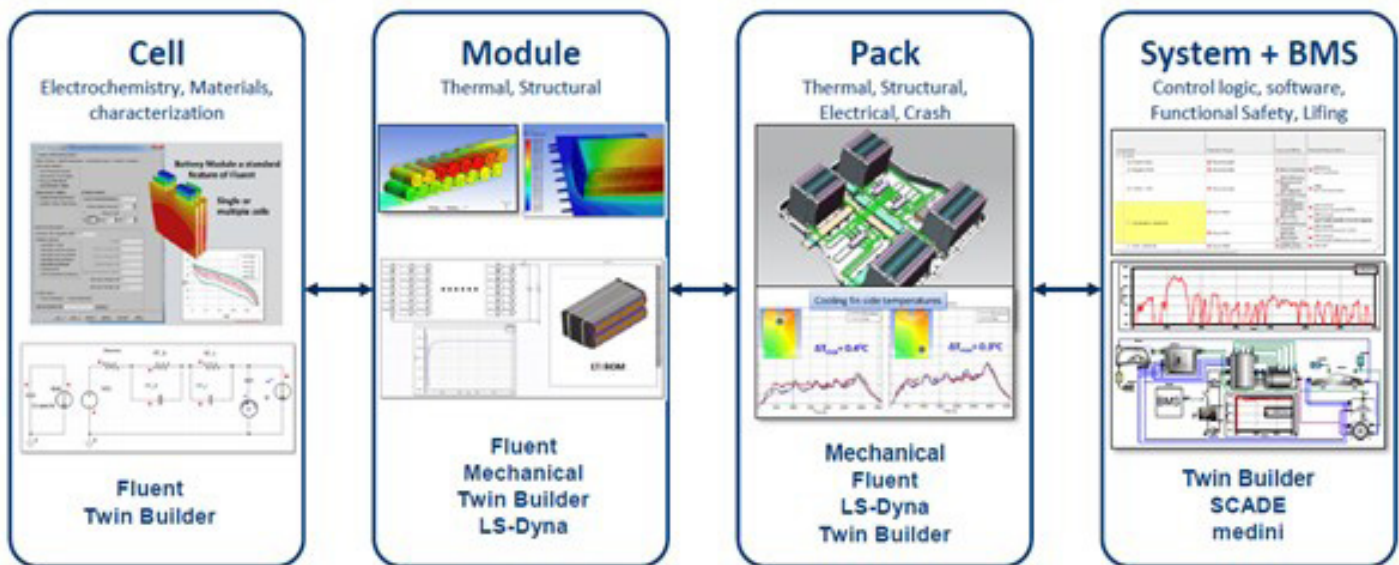

Figure 16 Battery selector tool in Granta Selector

Figure 17 Using Ashby plots in Granta Selector to quickly compare battery chemistry options

The Ansys Multiphysics Solution.

Ansys has a well-developed, holistic solution to battery modeling and simulation that includes the cell, module, pack, and system. Ansys Materials tools and data can augment the resulting simulation by directly integrating these simulation packages and accurate material properties.



Ansys provides the best-in-class battery thermal management simulation solution for cost-effective cooling of devices and batteries. Typically, a robust numerical model is the key to understanding the thermal runaway propagation in a battery module or pack. In **Ansys Fluent**, a comprehensive 3D safety model for a lithium ion cell can be used to [propose battery configurations to mitigate thermal runaway](#).

Ansys Twin Builder lets you quickly perform battery system modeling with a dedicated and powerful battery Modelica library. With Twin Builder, you can create a simulation-based digital twin throughout the product life cycle from design to operations and maintenance of the battery, monitoring the health and remaining useful life of components in your asset, and gain an accurate perspective on how the Batter Management System (BMS) and battery will perform throughout their entire life cycle. [Learn more](#).

Engineers at Lucid motors also created electric and thermal models of their luxury electric vehicle’s battery pack using Mechanical, the structural mechanics solver, and Fluent to simulate electrode degradation during charge/discharge. By understanding the potential conditions that could degrade the electrodes during different drive cycles, engineers substantially increased the life of the battery. [Learn more](#).

/ 2.5. HOUSING

Right Material Properties. Lower Carbon Footprint.

Battery housings have the task of protecting the most sensitive and expensive components of a BEV. It must provide crash or intrusion protection, as well as fire safety, corrosion protection and electromagnetic (EM) shielding. Housings are also required for other components within the electrified powertrain, such as the electric motor. **Ansys Granta Advanced Materials — Electromagnetic** contains a variety of EM-absorbent foams and materials to be able to consider exacting frequency-dependent material properties needed for shielding.

Many suppliers and OEMs are competing more on the environmental credentials of the materials used within the vehicles themselves, thereby achieving more sustainable component design. A solution to accurately assess early design life cycle impact is to use the **Eco Audit** tool in Granta Selector. This uses key environmental impact indicators in Ansys’s unique MaterialUniverse™ dataset with actionable reports to identify which materials are driving environmental impact.

Example: Decrease embodied energy by 40% in a prospective design

A variety of materials could be proposed for a housing, given the above engineering criteria are met (corrosion, electromagnetic shielding, etc.). Next, the engineer would identify the life cycle and component driving the largest environmental impact using the Eco Audit tool (Figure 18).

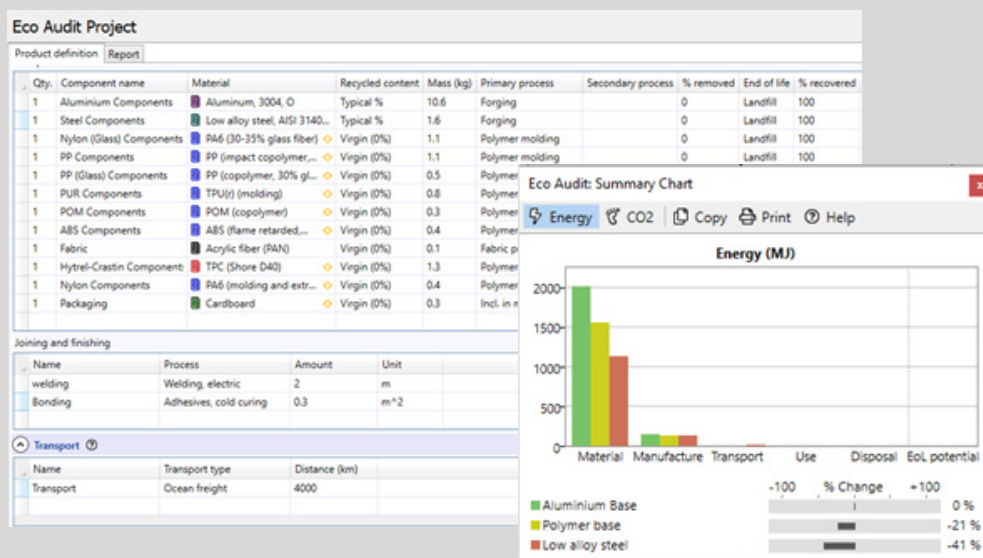

Figure 18 Eco Audit in Granta Selector

In this example, the raw material accounts for 68% of the overall embodied energy of the product. Therefore, a reduction in both embodied energy and carbon footprint can be achieved by several strategies, including moving to low-alloy steel and polymers with a lower environmental impact, using greater quantities of recycled material, or simply using less material if the design can permit this safely.

The Ansys Multiphysics Solution.

Once the appropriate material is selected in the Granta tool, the material card* can be exported to **Ansys LS-DYNA®** via Workbench, or via a pre-processor, to perform crash or intrusion protection simulation (Figure 19). This can be used to determine the amount of deformation needed in the housing to create a short, and the result of that short from cell to vehicle level. This optimized housing design and reinforcement makes for safer batteries or motors. See how LS-DYNA is being used [here](#).

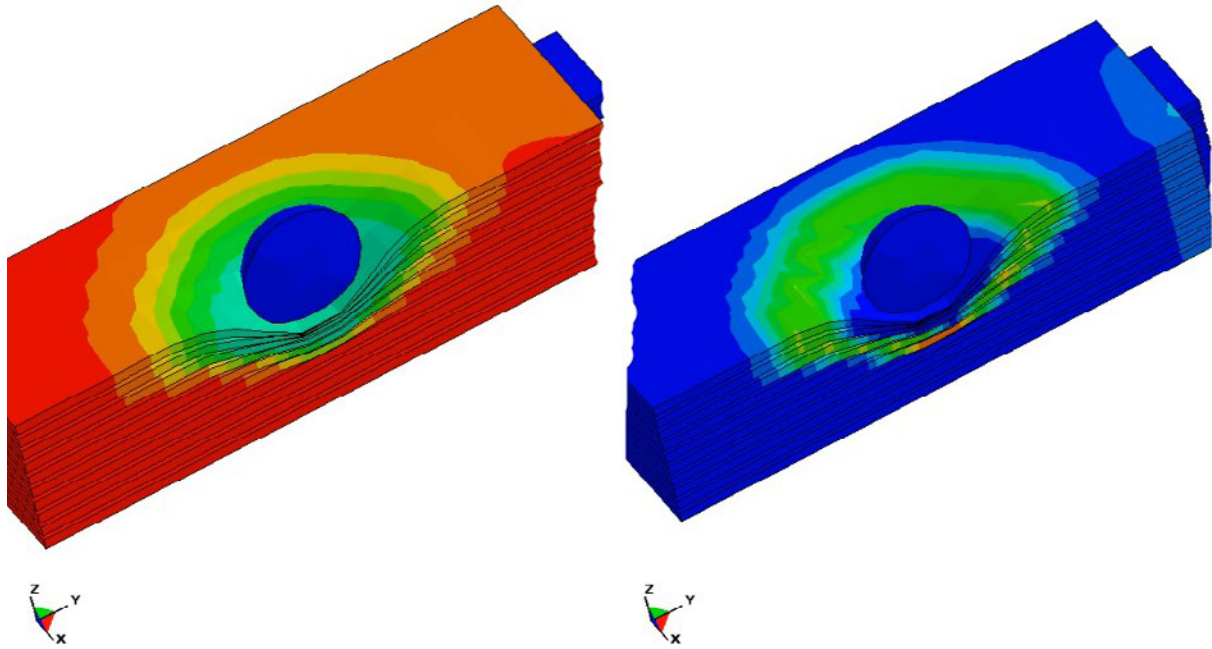

Figure 19 LS-DYNA crash simulation

Granta MI can then be used to store LS-DYNA curve data or advanced models that are generated. This can then be access controlled for use across the design and simulation team in an enterprise.

(*Note: This is the basic material property data (e.g., Young's modulus or density), not necessarily the curve data or advanced models.)

/ 2.6. HV WIRING

Materials to Ensure Robust Performance.

Both wires and cables must be chosen with care for any electric vehicle system. Types of insulation, temperatures around the wires, electromagnetic interference, longevity, and weight are a few considerations. Temperature is critical: The higher the temperature, the faster usable life is withdrawn from the cable.

Granta's core data (MaterialUniverse™ and JAHM-temperature dependent data) and our Granta Advanced Materials — Polymers data holds material property data for a variety of potential cable insulation types, e.g., PVC, TPU, or XLPE, with temperature-dependent data for many grades available. Using Granta MI™ or Granta Selector trade-offs with flexibility, mechanical strength, cost, and water resistance can be made depending on specific needs while maintaining the strict requirements regarding electrical and thermal performance in these applications. You can search, compare, and select the best material for the application and then export key materials property data for further design and simulation. See a [case study](#) for how Radiall was able to select the right material for their next-generation connectors.



The data is not restricted to polymers. Information on metals and high-performance alloys is available in our **Ansys Granta Advanced Materials — Metals** dataset, which is also an important part of JAHM and MaterialUniverse™. Physical, mechanical, temperature-dependent, thermal, electrical, durability, and environmental properties are available to enable you to find the best materials for your connectors and wiring.

The Ansys Multiphysics Solution.

Ansys EMA3D Cable enables engineers to efficiently assess complex cable harness system designs and evaluate protection schemes for vehicles of all sizes. With this dynamic workflow, you can significantly enhance cable harness compatibility designs and substantially decrease cost and risk on the path to electromagnetic compatibility certification.

Engineers developing high voltage wiring can also use **Ansys EMA3D Charge** to simulate electric arcing in air, surface and internal charging, particle transport, and dielectric breakdown. You can assign material properties from Granta.



/ 3. A CLEARER PATH TO USING MATERIALS IN POWERTRAIN ELECTRIFICATION

As should be evident, many different engineers are involved in the challenge of developing the next generation of electrified powertrains. But some questions each of them should be asking at the beginning of their design or simulation project are:

- Am I using the right material?
- Do the material properties, whether thermal, structural, or electromagnetic, reflect what I'm trying to solve?
- Do I need to design a new material for this application?

The features and functionality available in **Ansys Granta** (Figure 20) are designed to help answer these questions and work in unison with **Ansys Multiphysics** solvers across the spectrum.

MATERIALS DATA FOR SIMULATION
Focused materials data set to support simulation analysts, embedded into Ansys flagship products: Mechanical, Electronics Desktop, Fluent, Discovery and Motor-CAD

GRANTA SELECTOR
Intelligent materials selection combining powerful software tools and extensive property data. Find the optimal materials for your applications

GRANTA MI PRO
Fast-start, out-of-the-box materials information management solution for design and simulation

GRANTA MI ENTERPRISE
Comprehensive enterprise materials information management system

MATERIALS DATA
An unrivalled library of materials property data embedded within your Granta software

MaterialUniverse™
JAHM curve data

Metals Polymers Composites Aero Additive Manufacturing Medical Eco ESDU Electro-magnetics

Figure 20 Ansys Granta product range



Contact your Ansys Elite Channel Partner in the Nordics and UK, EDRMedeso.
<https://digitallabs.edrmedeso.com/>

ANSYS, Inc.
Southpointe
2600 Ansys Drive
Canonsburg, PA 15317
U.S.A.
724.746.3304
ansysinfo@ansys.com

If you've ever seen a rocket launch, flown on an airplane, driven a car, used a computer, touched a mobile device, crossed a bridge or put on wearable technology, chances are you've used a product where Ansys software played a critical role in its creation. Ansys is the global leader in engineering simulation. We help the world's most innovative companies deliver radically better products to their customers. By offering the best and broadest portfolio of engineering simulation software, we help them solve the most complex design challenges and engineer products limited only by imagination.

Visit www.ansys.com for more information.

Any and all ANSYS, Inc. brand, product, service and feature names, logos and slogans are registered trademarks or trademarks of ANSYS, Inc. or its subsidiaries in the United States or other countries. All other brand, product, service and feature names or trademarks are the property of their respective owners.

© 2022 ANSYS, Inc. All Rights Reserved.